

TWO VALVE MANIFOLDS

REMOTE MOUNT (PIPE TO PIPE)



MODEL CODE : K2VH

With threaded horizontal port inlet, outlet and vent/test connection on the left hand side. The venting bonnet is positioned on the top and the isolating bonnet on the front.

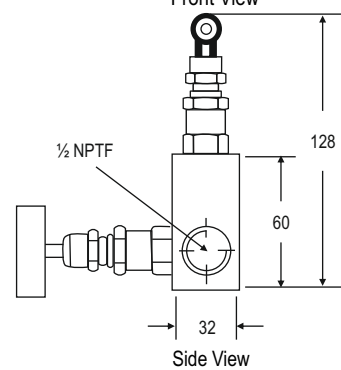
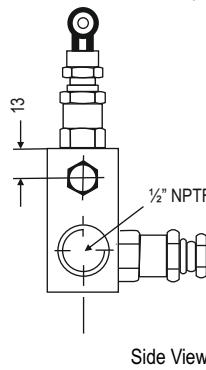
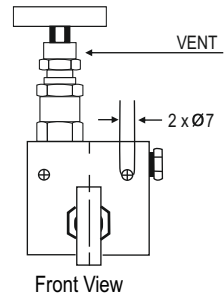
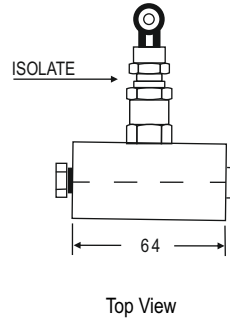
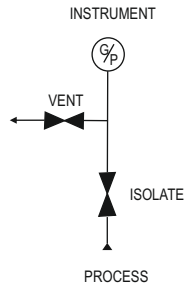
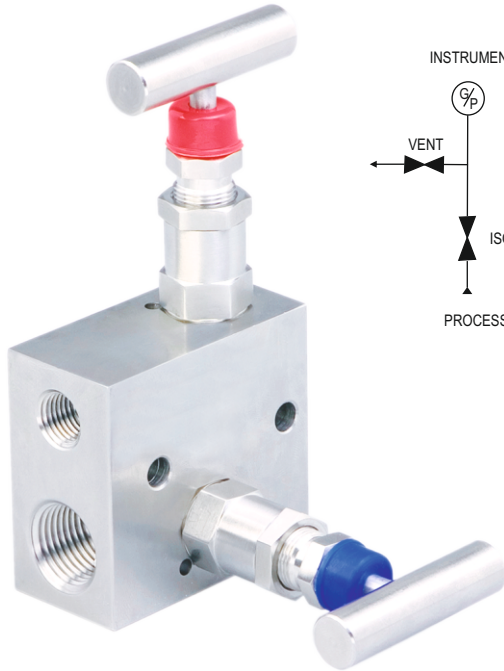

STANDARD CONNECTION

Product	Process side	Instrument side	Vent/Test
K2VH	1/2" NPT female	1/2" NPT female	1/4" NPT female

MODEL CODE : K2VT

With threaded vertical port inlet and female outlet. The vent/test connection is positioned on the front side. The venting bonnet is positioned on the right hand side and the isolating bonnet on left hand side.

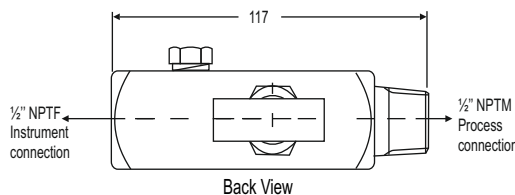
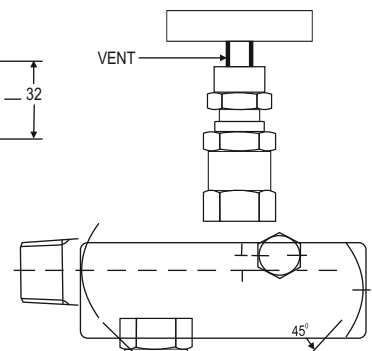
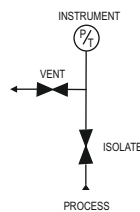
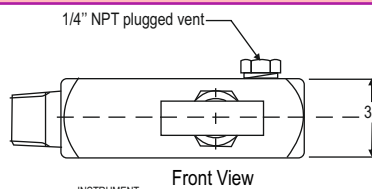
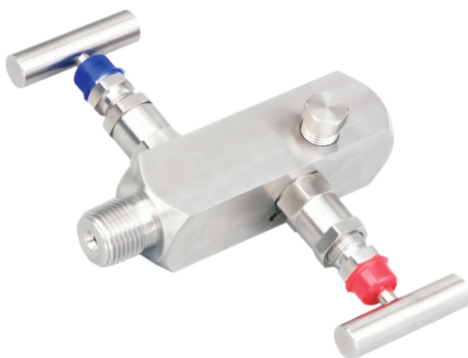

STANDARD CONNECTION

Product	Process side	Instrument side	Vent/Test
K2VT	1/2" NPT male	1/2" NPT female	1/4" NPT female



MANIFOLDS

KLEEV USA INC.

833 Claude Laurel Dr, Apex, NC 27523, USA Telephone : +1(919)-924-0408 Fax : +1(919)-267-3859

Email : info@kleevusa.com Website : www.kleevusa.com

TWO VALVE MANIFOLDS

REMOTE MOUNT (PIPE TO PIPE)



MODEL CODE : K2VA

With threaded horizontal port inlet and outlet and vent/test connection on the right hand side. The venting bonnet is positioned angular on the top and the isolating bonnet on the front.

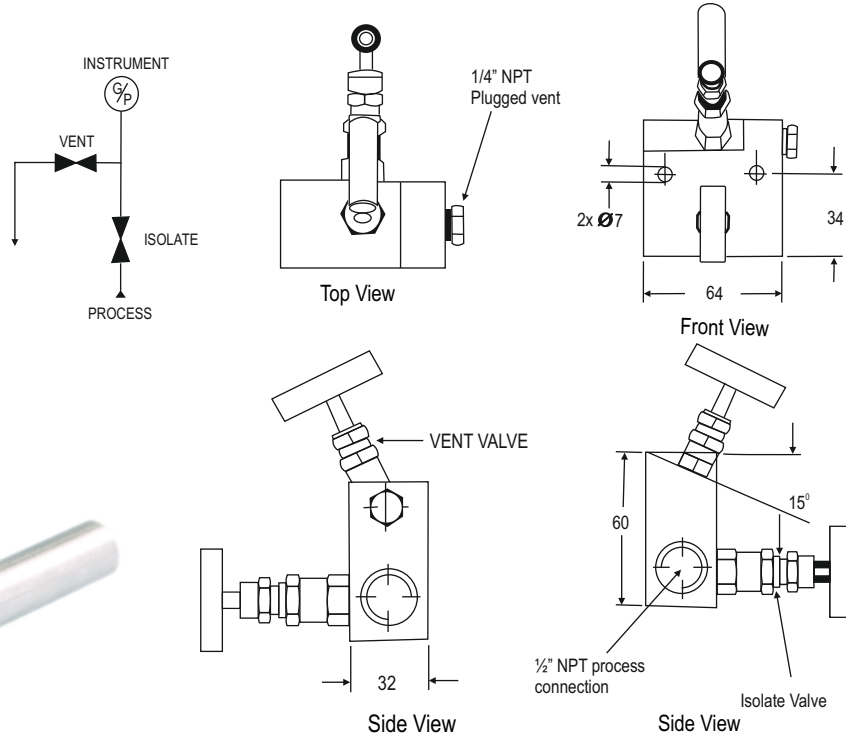
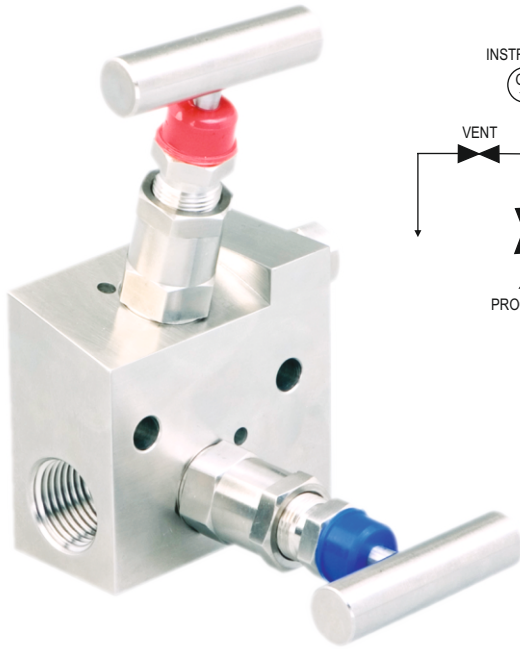

STANDARD CONNECTION

Product	Process side	Instrument side	Vent/Test
K2VA	1/2" NPT female	1/2" NPT female	1/4" NPT female

MODEL CODE : K2VTF

With the vent is positioned near the male instrument connection side.

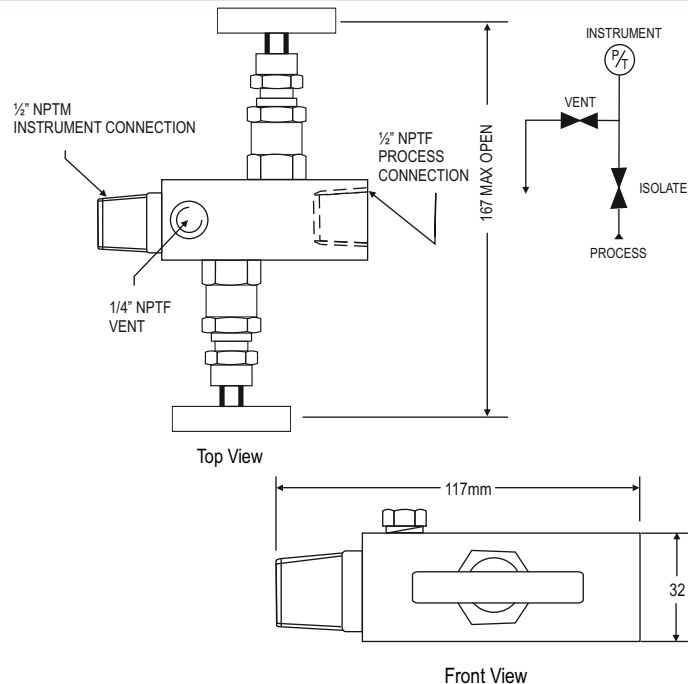
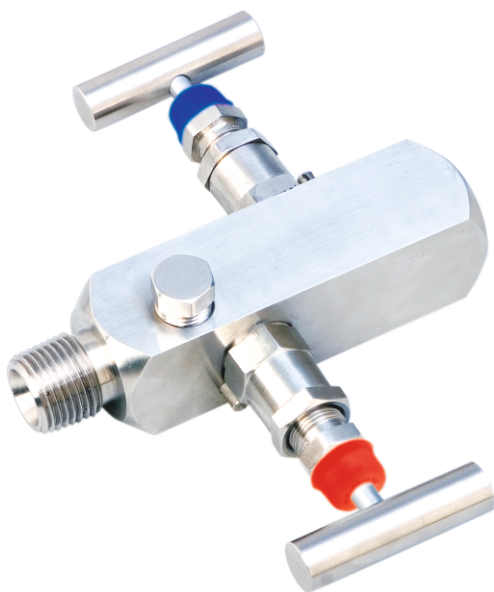

STANDARD CONNECTION

Product	Process side	Instrument side	Vent/Test
K2VTF	1/2" NPT Female	1/2" NPT Male	1/4" NPT Female



MANIFOLDS

KLEEV USA INC.

833 Claude Laurel Dr, Apex, NC 27523, USA Telephone : +1(919)-924-0408 Fax : +1(919)-267-3859

Email : info@kleevusa.com Website : www.kleevusa.com

TWO VALVE MANIFOLDS

REMOTE MOUNT (PIPE TO PIPE)



MODEL CODE : K2VS

With threaded vertical port inlet and outlet. The vent/test connection is positioned on the front side. The drain bonnet is positioned on the right hand side and the isolating bonnet on the left hand side.

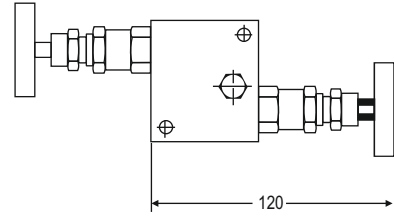
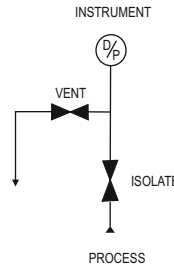
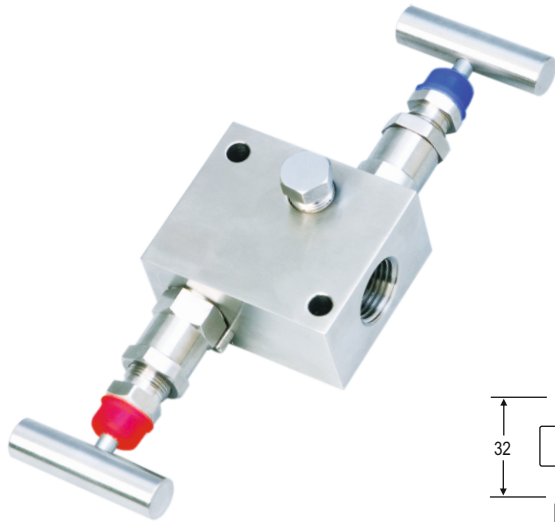

Top View

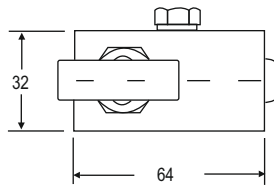

Side View

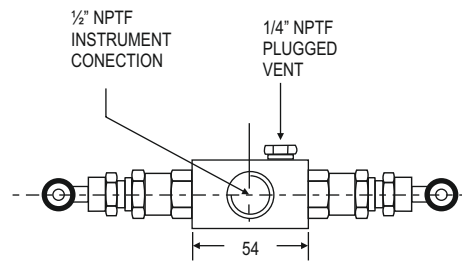

Front View

STANDARD CONNECTION

Product	Process side	Instrument side	Vent/Test
K2VS	1/2" NPT female	1/2" NPT female	1/4" NPT female

MODEL CODE : K2VM

With threaded horizontal port inlet, outlet and vent/test connection on the left hand side. The venting bonnet is positioned on the top and the isolating bonnet on the front.

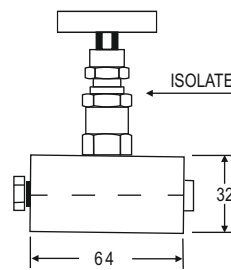
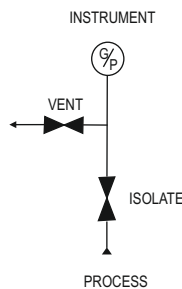
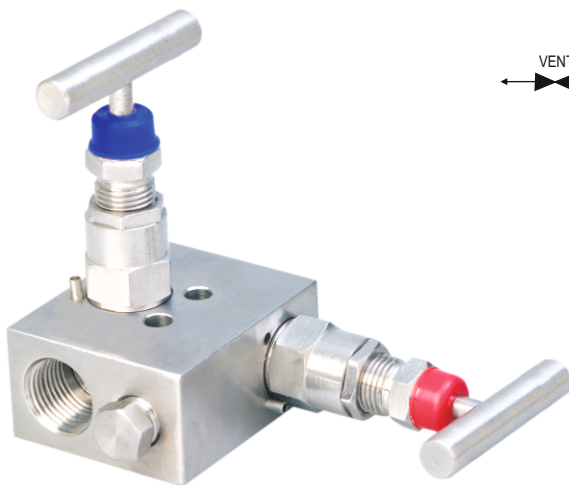

Front View

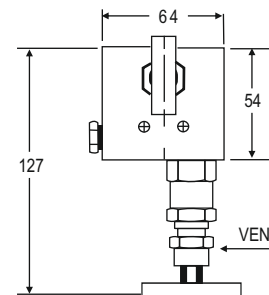

Top View

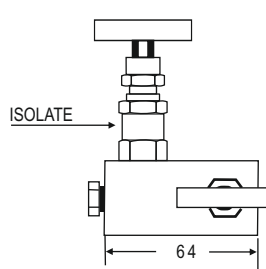

Side View

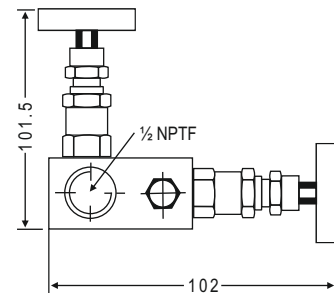

Front View

STANDARD CONNECTION

Product	Process side	Instrument side	Vent/Test
K2VM	1/2" NPT female	1/2" NPT female	1/4" NPT female



MANIFOLDS

KLEEV USA INC.

833 Claude Laurel Dr, Apex, NC 27523, USA Telephone : +1(919)-924-0408 Fax : +1(919)-267-3859

Email : info@kleevusa.com Website : www.kleevusa.com

TWO VALVE MANIFOLDS

REMOTE MOUNT (PIPE TO PIPE)



MODEL CODE : K2VH, K2VT, K2VA, K2VTF, K2VS, K2VM

SPECIFICATIONS - STANDARD VERSION : K2VH, K2VT, K2VA, K2VTF, K2VS, K2VM

Body	: SS 316
Stem	: SS 316
Valve assembly	: SS 316
'T' bar handle	: SS 304
Maximum working pressure	: 6000 PSI
Maximum working temperature	: 240°C
Packing	: PTFE
Type of stem	: Type CT; Stem with conical metal tip
Drain port	: 1/4" NPT [F]; provided with SS 316 plug
Bracket mounting holes	: 2 Nos. (Not available in Series 2VT, 2VTF)
Hard Chrome plating	: Provided on stem tip.

HOW TO ORDER

BASIC MODEL : K2VH, K2VT, K2VA, K2VTF, K2VS, K2VM

Body Material	Stem Type	Stem Packing	Size = Inlet x Outlet	Connections	Threads
C = Carbon Steel	CT	P = PTFE	24 = 1/4" x 1/4"	MF = Male x Female	N = NPT (ANSI B 1.20.1)
S = SS 316	DS	G = Grafoil	33 = 3/8" x 3/8"	FF = Female x Female	P = BSPP
S4 = SS 304			44 = 1/2" x 1/2"	SW = Socket weld	(BS 2779, ISO 228/1)
SL = SS 316L			66 = 3/4" x 1/2"	FM = Female x Male	B = BSPT (BS 21, ISO 7/1)
M4 = Monel 400			2F = 1/4"x Flange		
M5 = Monel 500			3F = 3/8"x Flange		
H = Hastelloy C			4F = 1/2"x Flange		

OPTIONS

- IE : Handle circular.
- TF : Compliance to NACE standard MR-0175.
- SG : For Oxygen service, valves are supplied cleaned, degreased and suitably packed.
- GH : Material test certificate
- GO : Hydro test certificate
- MBC : Mounting bolts (7/16" UNF) in carbon steel (Model : MBC - M45, MBC - M25)
- MBS : Mounting bolts (7/16" UNF) in SS (Model : MBS - M45, MBS - M25)
- MB : Mounting Bracket
- ATV : Anti Tamper valve
- ATK : Anti Tamper key

Ordering Example:

To place an order simply refer to the codes in the table.

Valve Type : **Body Material** + **Stem Type** + **Stem Packing** + **Size** + **Connections** + **Threads** + **Options**
K2VA + **S** + **CT** + **P** + **44** + **FF** + **N** = **K2VA-S-CT-P-44-FF-N-Options**

NOTE:

- The weld prepared types are available with female plain end - suitable for socket weld.
- Anti-tamper bonnet - special design on request with locking arrangement if desired.



MANIFOLDS

KLEEV USA INC.

833 Claude Laurel Dr, Apex, NC 27523, USA Telephone : +1(919)-924-0408 Fax : +1(919)-267-3859

Email : info@kleevusa.com Website : www.kleevusa.com