

FIVE VALVE MANIFOLDS

REMOTE MOUNT (PIPE TO PIPE)



MODEL CODE : K5VA

With threaded vertical port inlets and outlets. The isolating and venting bonnets are positioned on the left and right hand side and the equalizing bonnet is positioned on the front side. Designed for remote mounting.

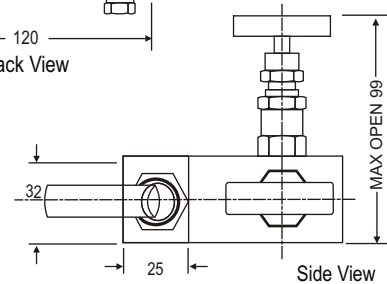
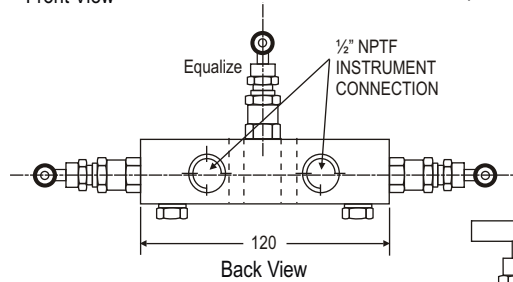
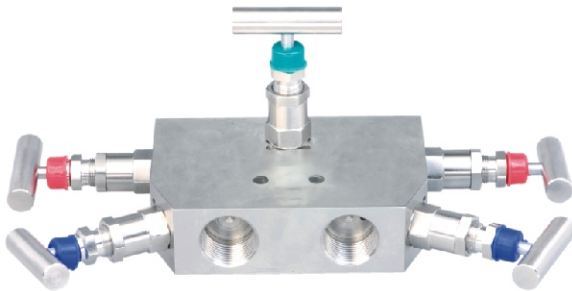
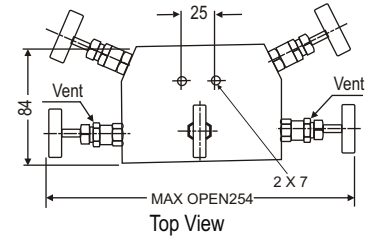
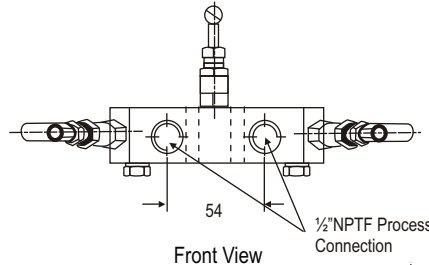
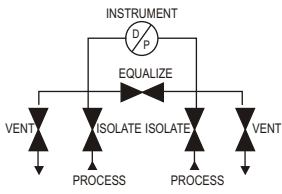

Standard connection

Product	Process side	Instrument side	Vent/Test
5VA	1/2" NPT female	1/2" NPT female	1/4" NPT female

VM - 5VA - 01 - 2009 / 10

MODEL CODE : K5VG

With threaded vertical port inlets and outlets. The vent/test ports are positioned on the bottom and top of the body. The isolating bonnets are positioned on the left and right hand side and the venting and equalizing bonnets are positioned on the front side. Specially designed for remote mounting to field meters, differential transmitters and chart recorders on gas service allowing fail safe configuration preventing pressure loss from the high to low pressure impulse lines.

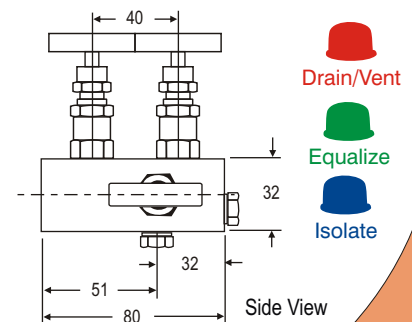
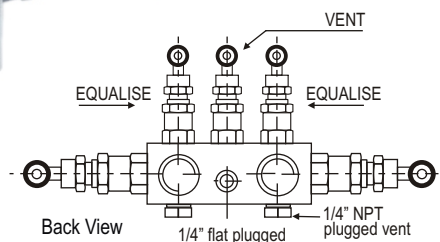
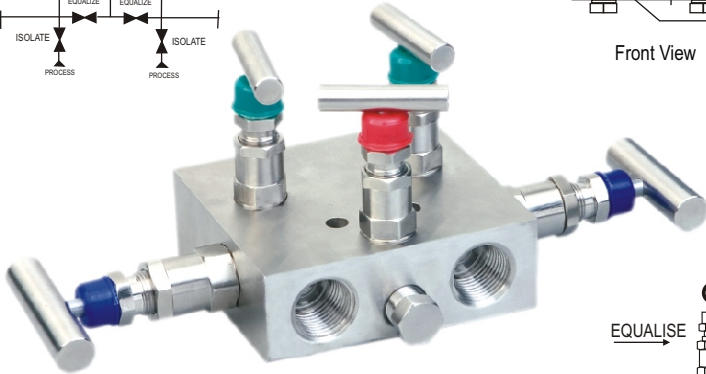
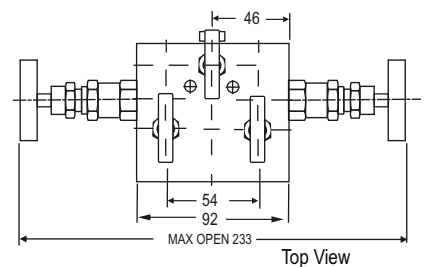
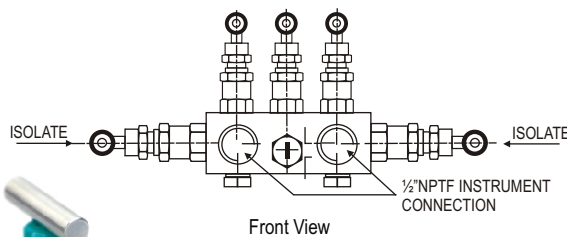
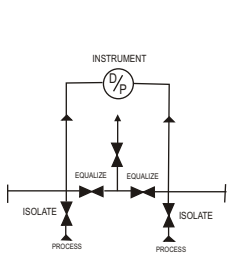

Standard connection

Product	Process Side	Instrument Side	Vent/Test
5VG	1/2" NPT female	1/2" NPT female	1/4" NPT female

KLEEV USA INC.

833 Claude Laurel Dr, Apex, NC 27523, USA Telephone : +1(919)-924-0408 Fax : +1(919)-267-3859

Email : info@kleevusa.com Website : www.kleevusa.com

MANIFOLDS

FIVE VALVE MANIFOLDS

REMOTE MOUNT (PIPE TO PIPE)



MODEL CODE : K5VD

Series for differential pressure gauges with 2 inlets NPT female at bottom and 2 outlets with rotating nuts on top side.
Also available in 50mm tap spacings Series - 5VD50.

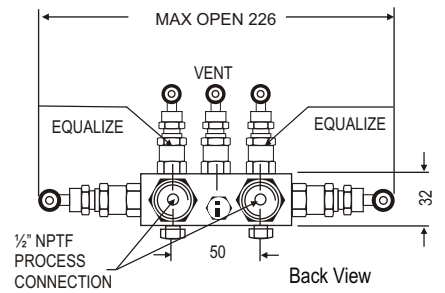
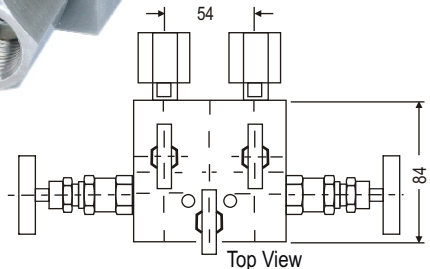
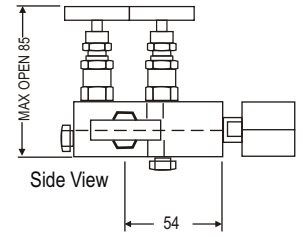
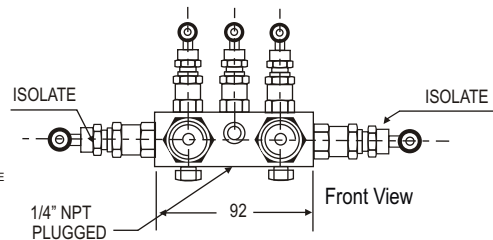
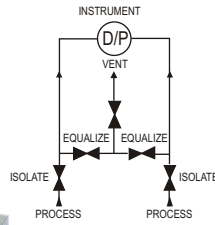
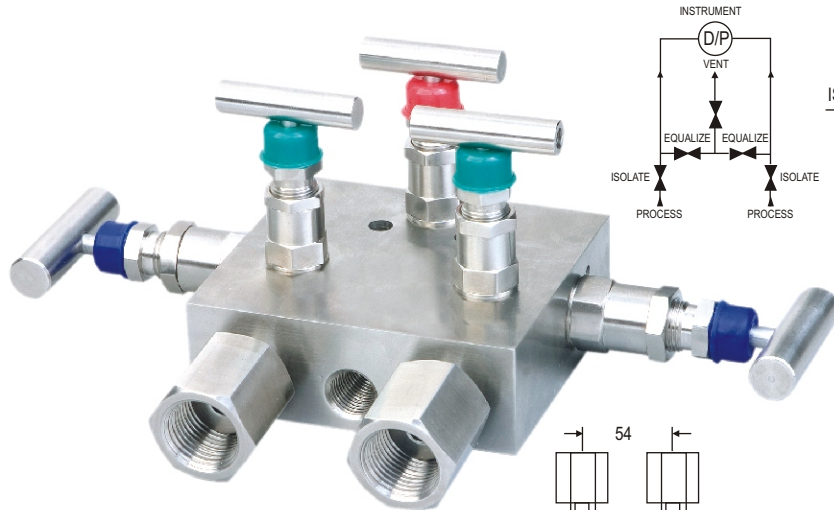

Standard connection

Product	Process side	Instrument side	Vent/Test
5VD	1/2" NPT female	1/2" BSP Rotatable nuts	1/4" NPT female

MODEL CODE : K5VQ

Series designed for complete isolation of instruments-2 inlets NPT female at front, 2 outlets NPT female at back side. Vent/test connection at front, equalizing bonnets and Isolating bonnets on angular top, venting bonnets at left and right side.

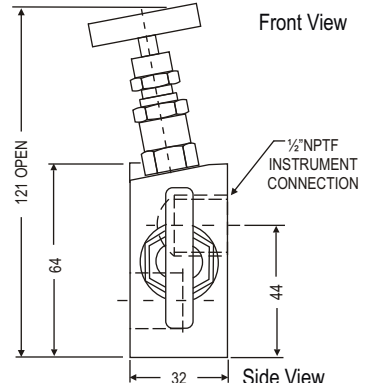
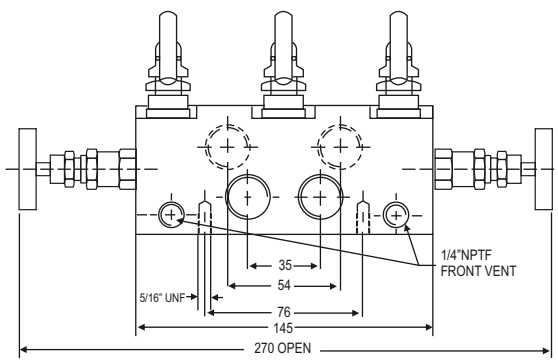
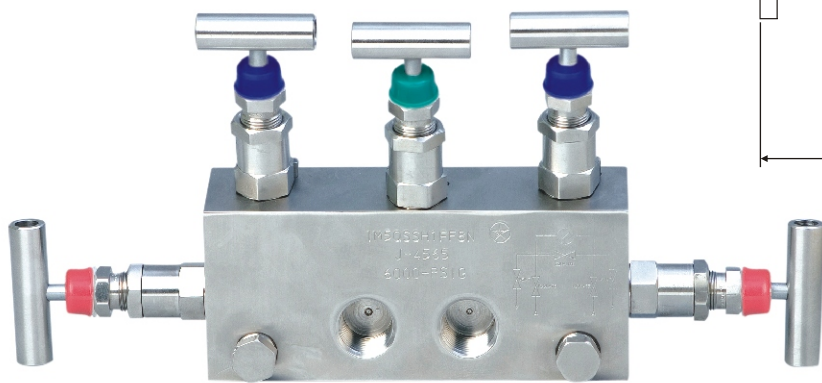
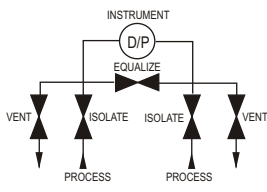

Standard connection

Product	Process Side	Instrument Side	Vent/Test
5VQ	1/2" NPT female	1/2" NPT female	1/4" NPT female

KLEEV USA INC.

833 Claude Laurel Dr, Apex, NC 27523, USA Telephone : +1(919)-924-0408 Fax : +1(919)-267-3859

Email : info@kleevesusa.com Website : www.kleevesusa.com

MANIFOLDS

FIVE VALVE MANIFOLDS

REMOTE MOUNT (PIPE TO PIPE)



MODEL CODE : K5VV

Model designed for complete isolation of instruments with NPT female inlets /outlets. Vent/test connection at bottom; equalizing bonnet angular on top-isolating bonnets angular on top venting bonnets at left and right side.

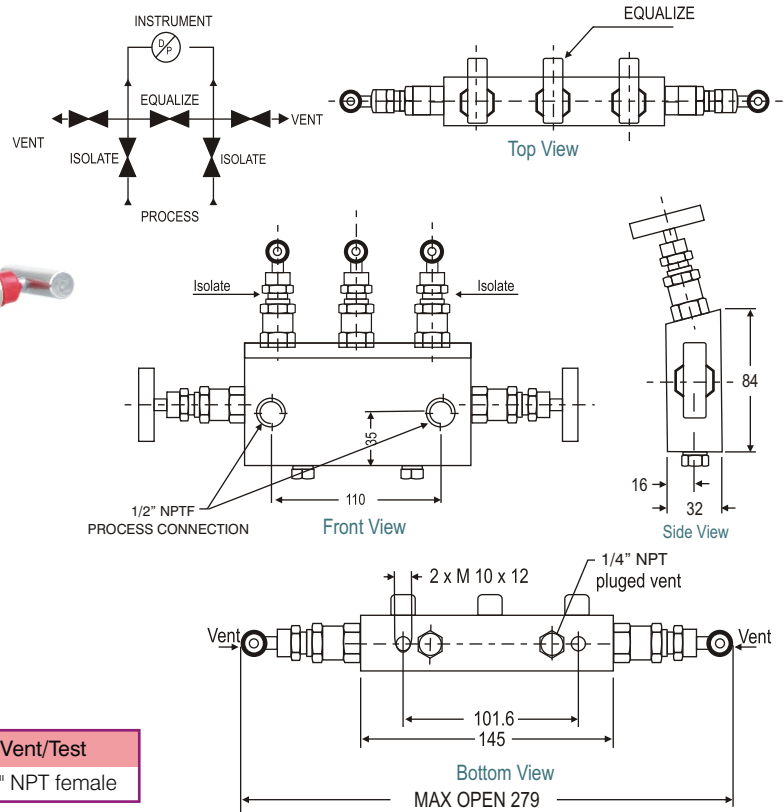

STANDARD CONNECTION

Product	Process side	Instrument side	Vent/Test
5VV	1/2" NPT female	1/2" NPT female	1/4" NPT female

MODEL CODE : K5VR

With threaded female ports on front side and back side for instrument and process connections. The two vent bonnets along with equalizing bonnet are positioned on the top side. The two isolation bonnets are positioned on left and right hand sides.

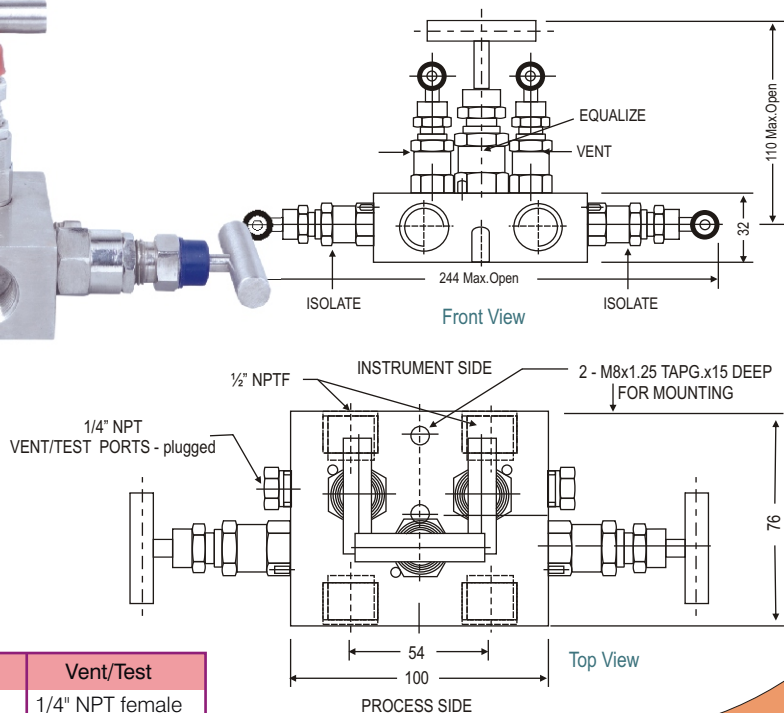
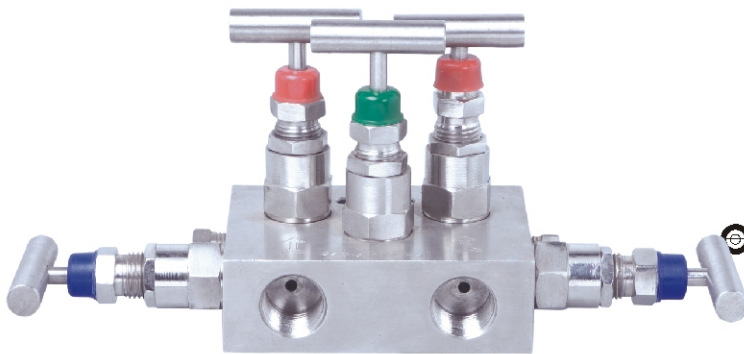

STANDARD CONNECTION

Product	Process side	Instrument side	Vent/Test
5VR	1/2" NPT female	1/2" NPT female	1/4" NPT female

KLEEV USA INC.

833 Claude Laurel Dr, Apex, NC 27523, USA Telephone : +1(919)-924-0408 Fax : +1(919)-267-3859

Email : info@kleevesusa.com Website : www.kleevesusa.com

MANIFOLDS

FIVE VALVE MANIFOLDS

REMOTE MOUNT (PIPE TO PIPE)



MODEL CODE : K5VA, K5VG, K5VD, K5VQ, K5VV, K5VR

SPECIFICATIONS - STANDARD VERSION : K5VA, K5VG, K5VD, K5VQ, K5VV, K5VR

Body	: SS 316
Stem	: SS 316
Valve assembly	: SS 316
'T' bar handle	: SS 304
Maximum working pressure	: 6000 PSI
Maximum working temperature	: 240°C
Packing	: PTFE
Type of stem	: Type CT; Stem with conical metal tip
Drain port	: 1/4" NPT [F]; provided with SS 316 plug
Bracket mounting holes	: 2 Nos.
Hard Chrome plating	: Provided on stem tip.

HOW TO ORDER

BASIC MODEL : K5VA, K5VG, K5VD, K5VQ, K5VV, K5VR

Body Material	Stem Type	Stem Packing	Size = Inlet x Outlet	Connections	Threads
C = Carbon Steel	CT	P = PTFE	44= 1/2" x 1/2" (std)	FF = Female x Female	N = NPT (ANSI B 1.20.1)
S = SS 316	DS	G = Grafoil	24 = 1/4" x 1/4"	FR = Female x Female	P = BSPP
S4 = SS 304				Rotating	(BS 2779, ISO 228/1)
SL = SS 316L				SW = Socket weld	B = BSPT (BS 21, ISO 7/1)
M4 = Monel 400				MR = Male x Female	
M5 = Monel 500				Rotating	
H = Hastelloy C					

OPTIONS

- IE : Handle circular.
- TF : Compliance to NACE standard MR-0175.
- SG : For Oxygen service, valves are supplied cleaned, degreased and suitably packed.
- GH : Material test certificate
- GO : Hydro test certificate
- MB : Mounting Bracket
- MBC : Mounting bolts (7/16" UNF) in carbon steel (Model : MBC - M45, MBC - M25)
- MBS : Mounting bolts (7/16" UNF) in SS (Model : MBS - M45, MBS - M25)
- BLD4 : Bleeder 1/4" NPT (Male)
- ATV : Anti Tamper valve
- ATK : Anti Tamper key

Ordering Example:

To place an order simply refer to the codes in the table.

Valve Type : **Body Material** + **Stem Type** + **Stem Packing** + **Size** + **Connections** + **Threads** + **Options**
K5VA + **S** + **CT** + **P** + **44** + **FF** + **N** = **K5VA-S-CT-P-44-FF-N-Options**

NOTE:

- The weld prepared types are available with female plain end - suitable for socket weld.
- Anti-tamper bonnet - special design on request with locking arrangement if desired.



Drain/Vent Equalize Isolate

MANIFOLDS

KLEEV USA INC.

833 Claude Laurel Dr, Apex, NC 27523, USA Telephone : +1(919)-924-0408 Fax : +1(919)-267-3859

Email : info@kleevusa.com Website : www.kleevusa.com